

Series **2**

---

DIGITAL FORCE GAUGES

# User's Guide

**MARK-10**<sup>®</sup>

## Thank you...



Thank you for purchasing a Mark-10 Series 2 digital force gauge, designed for tension and compression force testing applications from 2 to 500 lbF (10 to 2,500 N) full scale. The Series 2 is an essential component of a force testing system, typically also comprising a test stand and grips.

With proper usage, we are confident that you will get many years of great service with this product. Mark-10 force gauges are ruggedly built for many years of service in laboratory and industrial environments.

This User's Guide provides setup, safety, and operation instructions. Dimensions and specifications are also provided. For additional information or answers to your questions, please do not hesitate to contact us. Our technical support and engineering teams are eager to assist you.

**Before use, each person who is to use the Series 2 force gauge should be fully trained in appropriate operation and safety procedures.**

## TABLE OF CONTENTS

OVERVIEW .....	2
POWER .....	3
MECHANICAL SETUP .....	4
HOME SCREEN AND CONTROLS .....	6
OPERATING MODES .....	7
CHANGING THE UNITS .....	7
DIGITAL FILTERS .....	8
CALIBRATION .....	8
OTHER SETTINGS .....	13
SPECIFICATIONS .....	15

## 1 OVERVIEW

### 1.1 List of included items

Qty.	Description
1	Digital force gauge
1	8.4V rechargeable battery (inside the gauge)
1	Resource CD

### 1.2 List of optional items

Part No.	Description
12-1049	Carrying case
CERT	Certificate of calibration with data
G1038	Medium hook, #10-32M (requires G1039)
G1039	Coupling, #10-32F/F
G1029	Flat head, #10-32F
G1026	Cone, #10-32F
G1025	Chisel point, #10-32F
G1027	V-groove, #10-32F
G1024	Extension rod, 5", #10-32F
G1035	Large hook, 5/16-18M (requires G1037)
G1037	Coupling, 5/16-18F/F
G1036	Flat head, 5/16-18F
G1033	Cone, 5/16-18F
G1032	Chisel point, 5/16-18F
G1034	V-groove, 5/16-18F
G1031	Extension rod, 5", 5/16-18F

### 1.3 Safety / Proper Usage

#### Caution!

**Note the force gauge's capacity before use and ensure that the capacity is not exceeded. Producing a force greater than 200% of the gauge's capacity can damage the internal load cell. An overload can occur whether the gauge is powered on or off.**

Typical materials suitable for testing include many manufactured items, such as springs, electronic components, fasteners, caps, films, mechanical assemblies, and many others. Items that should not be used with the gauge include potentially flammable substances or products, items that can shatter in an unsafe manner, and any other components that can present an exceedingly hazardous situation when acted upon by a force.

The following safety checks and procedures should be performed before and during operation:

1. Never operate the gauge if there is any visible damage to the AC adapter or the gauge itself.
2. Ensure that the gauge is kept away from water or any other electrically conductive liquids at all times.
3. The gauge should be serviced by a trained technician only. AC power must be disconnected and the gauge must be powered off before the housing is opened.

4. Always consider the characteristics of the sample being tested before initiating a test. A risk assessment should be carried out beforehand to ensure that all safety measures have been addressed and implemented.
5. Wear eye and face protection when testing, especially when testing brittle samples that have the potential to shatter under force. Be aware of the dangers posed by potential energy that can accumulate in the sample during testing. Extra bodily protection should be worn if a destructive failure of a test sample is possible.
6. In certain applications, such as the testing of brittle samples that can shatter, or other applications that could lead to a hazardous situation, it is strongly recommended that a machine guarding system be employed to protect the operator and others in the vicinity from shards or debris.
7. When the gauge is not in use, ensure that the power is turned off.

## 2 POWER

---





### Caution!

**Do not use AC adapters other than supplied or instrument damage may occur.**

The gauge is powered either by an 8.4V rechargeable battery or by an AC adapter (input jack is located in the left side of the housing).

If the AC adapter is plugged in, an icon appears in the lower left corner of the display, as follows: 

If the AC adapter is not plugged in, battery power drainage is denoted in a five-step process:

1. When battery life is greater than 75%, the following indicator is present: 
2. When battery life is between 50% and 75%, the following indicator is present: 
3. When battery life is between 25% and 50%, the following indicator is present: 
4. When battery life is less than 25%, the following indicator is present: 
5. When battery life drops to approximately 2%, the indicator from step 4 will be flashing. Several minutes after (timing depends on usage and whether the backlight is turned on or off), a message appears, "BATTERY VOLTAGE TOO LOW. POWERING OFF". An audio tone will sound and the gauge will power off.

The gauge can be configured to automatically power off following a period of inactivity. Refer to the **Other Settings** section for details.

Battery life is approximately 24 hours with the backlight off, or 7 hours with the backlight on. To change the battery, loosen the two captive screws on the back side of the housing and separate the two housing halves. A foam strip separates the battery from the PCB, as shown in the illustration below:



Ensure that the foam is positioned above the battery when reassembling the housing. Exercise care when reassembling the two halves of the housing, ensuring that internal wires do not interfere.

### 3 MECHANICAL SETUP

#### 3.1 Loading shaft orientation

In order to accommodate a variety of testing requirements, the orientation of the loading shaft may be oriented in either of the two positions shown below. To change the loading shaft orientation, loosen the two captive screws on the back side of the housing, separate the two housing halves, rotate one half 180 degrees, and reassemble. Exercise care when reassembling the two halves of the housing, ensuring that internal wires do not interfere.

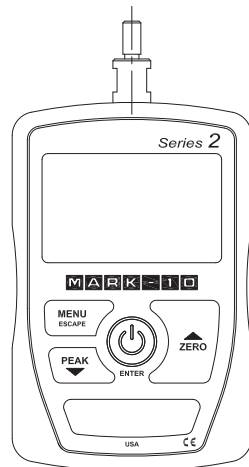

Load cell shaft up

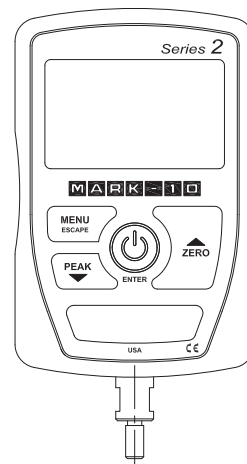

Load cell shaft down

### 3.2 Mounting to a plate

Although the gauge may be used by hand, proper mounting is important if attached to a fixture or test stand. The round steel insert with a hole in the back of the housing is provided to withstand the load during a test. A mating dowel pin should be used (see illustration below). Mounting plates on Mark-10 test stands include a dowel pin and clearance holes for the four threaded holes located near the corners of the housing. An additional two holes are supplied for metric screws. These holes are designed to accommodate screws in order to hold the gauge in place (Mark-10 test stands include a set of thumb screws for gauge mounting). The screws must **not** be used for load bearing purposes. Failure to use a dowel pin properly can result in a hazardous situation.

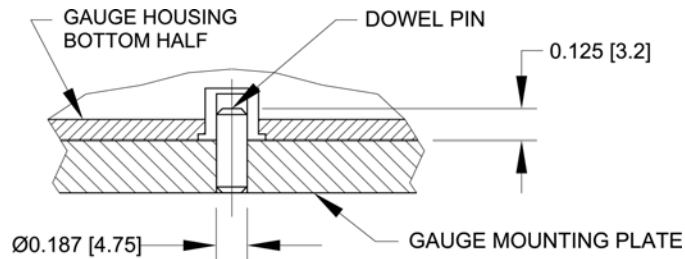

### 3.3 Mounting attachments to the gauge



The force gauge's threaded loading shaft is designed to accommodate common grips and attachments with female mounting holes. To mount a grip, gently thread it onto the shaft. Ensure that the grip or fixture is positioned to ensure axial load with respect to the loading shaft of the force gauge. When using a grip, ensure that it secures the sample in such a way that it is prevented from slipping out during a test, preventing a potential safety risk to the operator and others in the vicinity. If using a grip or fixture from a supplier other than Mark-10, ensure that it is constructed of suitably rugged materials and components.

Do not use jam nuts or tools to tighten grips or attachments onto the shaft. **Finger-tighten only.**

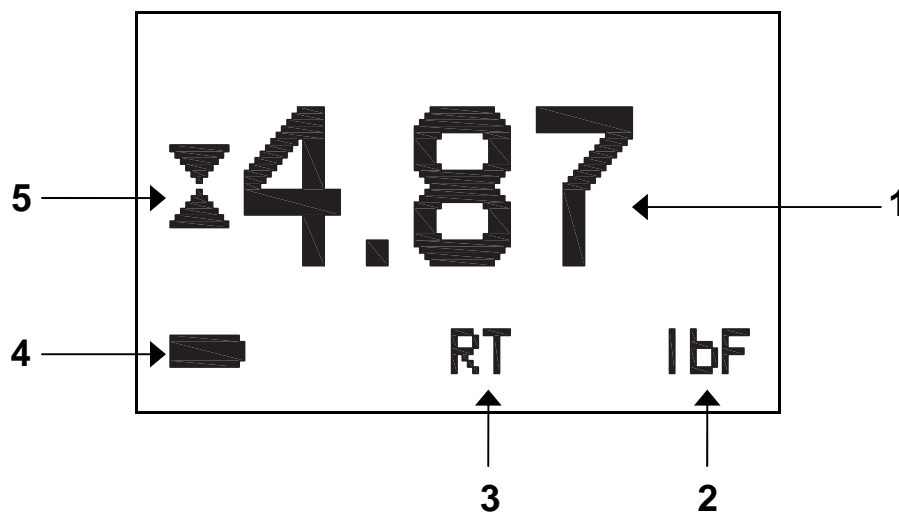

## 4 HOME SCREEN AND CONTROLS

### 4.1 Home Screen



No.	Name	Description
1	Primary reading	The current displayed force reading. See <b>Operating Modes</b> section for details.
2	Units	The current unit of measurement. Abbreviations are as follows: lbF – Pound-force kgF – Kilogram-force N – Newton
3	Mode	The current measurement mode. Abbreviations are as follows: RT – Real Time PC – Peak Compression PT – Peak Tension See <b>Operating Modes</b> section for details about each of these modes
4	Battery / AC adapter indicator	Either the AC adapter icon or battery power icon will be shown, depending on power conditions. Refer to the <b>Power</b> section for details.
5	Tension / compression indicator	 - indicates a tension (pull) direction  - indicates a compression (push) direction

### 4.2 Controls

Primary Label	Primary Function	Secondary Label	Secondary Function
	Powers the gauge on and off. Press briefly to power on, press and hold to power off. Active only when the home screen is displayed.	<b>ENTER</b>	Various uses, as described in the following sections.
<b>ZERO</b>	Zeroes the primary reading.	 <b>(UP)</b>	Navigates up through the menu and sub-menus.
<b>MENU</b>	Enters the main menu.	<b>ESCAPE</b>	Reverts one step backwards through the menu hierarchy.
<b>PEAK</b>	Toggles between real-time and peak measurement modes.	 <b>(DOWN)</b>	Navigates down through the menu and sub-menus.

**Note:** Units are configured through the menu. Refer to the **Changing The Units** section for details.

### 4.3 Menu navigation basics

Most of the gauge's various functions and parameters are configured through the main menu. To access the menu press **MENU**. Use the **UP** and **DOWN** keys to scroll through the items. The current selection is denoted with clear text over a dark background. Press **ENTER** to select a menu item, then use **UP** and **DOWN** again to scroll through the sub-menus. Press **ENTER** again to select the sub-menu item.

For parameters that may be either selected or deselected, press **ENTER** to toggle between selecting and deselecting. An asterisk (\*) to the left of the parameter label is used to indicate when the parameter has been selected.

For parameters requiring the input of a numerical value, use the **UP** and **DOWN** keys to increment or decrement the value. Press and hold either key to auto-increment at a gradually increasing rate. When the desired value has been reached, press **ENTER** to save the change and revert back to the sub-menu item, or press **ESCAPE** to revert back to the sub-menu item without saving. Press **ESCAPE** to revert one step back in the menu hierarchy until back into normal operating mode.

Refer to the following sections for details about setting up particular functions and parameters.

## 5 OPERATING MODES

### Caution!

**In any operating mode, if the capacity of the instrument has been exceeded by more than 110%, the display will show "OVER" to indicate an overload.**

Three operating modes are possible with Series 2 gauges. To cycle between the modes, press **PEAK** while in the home screen.

### 5.1 Real time (RT)

The primary reading corresponds to the live measured reading.

### 5.2 Peak Compression (PC)

The primary reading corresponds to the peak compression reading observed. If the actual force decreases from the peak value, the peak will still be retained in the primary reading area of the display. Pressing **ZERO** will reset the value.

### 5.3 Peak Tension (PT)

Same as Peak Compression, but for tension readings.

## 6 CHANGING THE UNITS

Series 2 gauges display one of three measurement units. To change the unit, select **Units** from the menu. The display appears as follows:

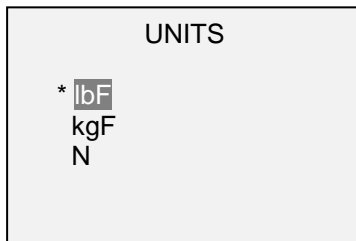

The gauge will always power on with the unit selected.



## 7 DIGITAL FILTERS

Digital filters are provided to help smooth out the readings in situations where there is mechanical interference in the work area or test sample. These filters utilize the moving average technique in which consecutive readings are pushed through a buffer and the displayed reading is the average of the buffer contents. By varying the length of the buffer, a variable smoothing effect can be achieved. The selection of 1 will disable the filter since the average of a single value is the value itself.

To access digital filter settings, select **Filters** from the menu. The display appears as follows:

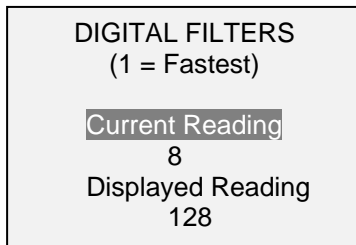

Two filters are available:

**Current Reading** – Applies to the peak capture rate of the instrument.

**Displayed Reading** – Applies to the primary reading on the display.

Available settings: 1,2,4,8,16,32,64,128,256,512,1024. It is recommended to keep the current reading filter at its lowest value for best performance, and the displayed reading filter at its highest value for best visual stability.

## 8 CALIBRATION

### 8.1 Initial Physical Setup

The gauge should be mounted vertically to a test stand or fixture rugged enough to withstand a load equal to the full capacity of the instrument. Certified deadweights or master load cells should be used, along with appropriate mounting brackets and fixtures. Caution should be taken while handling such equipment.

### 8.2 Calibration Procedure

1. Select **Calibration** from the menu. The display appears as follows:

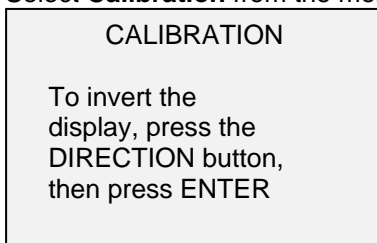

2. Press **DIRECTION** to invert the display, if desired. **ENTER** to continue. The display appears as follows:

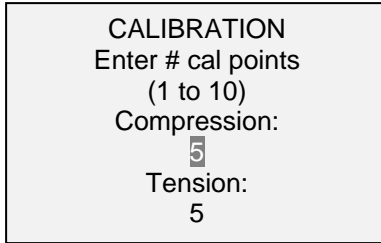

The gauge can be calibrated at up to 10 points in each direction. Enter the number of calibration points for each direction (compression and tension). At least one point must be selected for each direction.

**Note:** To achieve the accuracy specification of  $\pm 0.5\%$ , it is recommended to calibrate the gauge at 5 or more even increments in both tension and compression directions. For example, a gauge with capacity of 10 lbF should be calibrated at 2, 4, 6, 8, and 10 lb loads in each direction.

3. To escape the **Calibration** menu at any time, press **ESCAPE**. The display appears as follows:

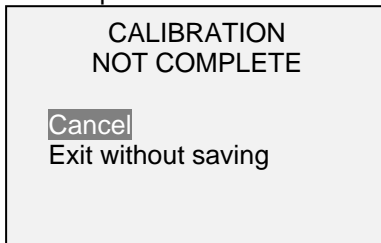

Selecting "Cancel" will revert back to the Calibration setup. Selecting "Exit without saving" will return to the menu without saving changes.

4. After the number of calibration points has been entered, press **ENTER**. The display appears as follows:

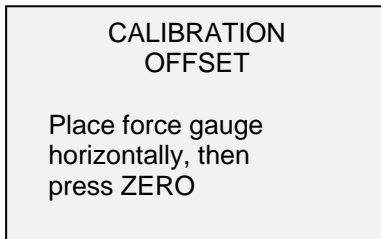

5. Place the force gauge horizontally on a level surface free from vibration, then press **ZERO**. The gauge will calculate internal offsets, and the display appears as follows:

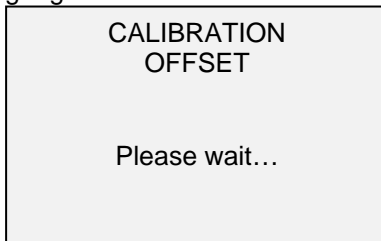

CALIBRATION  
OFFSET

Sensor Passed  
Analog Passed

If failed:

CALIBRATION  
OFFSET

Sensor Failed  
Analog Failed

6. The following screen appears after the offsets have been calculated:

CALIBRATION  
COMPRESSION

Attach necessary  
weight fixtures,  
then press ENTER

Attach weight fixtures (brackets, hooks, etc), as required. Do not yet attach any weights or apply any calibration loads. Press **ENTER**.

7. The display appears as follows:

CALIBRATION  
COMPRESSION

Optionally exercise  
sensor, then press  
ENTER

Optionally exercise the load cell shaft several times (at full scale, if possible), then press **ENTER**.

8. The display appears as follows:

CALIBRATION  
COMPRESSION  
Gain adjust  
Apply full scale load  
10.000 lbF +/-20%,  
Then press ENTER

Apply a weight equal to the full scale of the instrument, then press **ENTER**.

9. After displaying "Please wait..." the display appears as follows:

CALIBRATION  
COMPRESSION

Ensure no load

Then press ZERO

Remove the load applied in Step 8, leave the fixtures in place, then press **ZERO**.

10. The display appears as follows:

```
CALIBRATION
COMPRESSION
Apply load
1 OF 5
Enter load:
2.000 lbF
Press ENTER
```

Use the **UP** and **DOWN** keys to adjust the load value as required. The load values default to even increments, as indicated by the previously entered number of data points (even increments are recommended for best results). For example, if a 50 lbF capacity gauge is calibrated, and 5 data points were selected, the load values will default to 10, 20, 30, 40, and 50 lb. Apply the calibration load. Then press **ENTER**.

Repeat the above step for the number of data points selected.

11. After all the compression calibration points have been completed, the display appears as follows:

```
CALIBRATION
COMPRESSION COMPLETE
Reverse direction
for Tension
Attach necessary
weight fixtures,
then press ENTER
```

Press **ENTER**.

12. The display appears as follows:

```
CALIBRATION

To invert the
display, press the
DIRECTION button,
then press ENTER
```

Reverse the orientation of the load cell shaft by rotating the gauge 180 degrees. Press **DIRECTION** to invert the display. Then attach weight fixtures. The following screens will step through the same procedure as with the compression direction. Proceed in the same manner.

13. At the completion of the tension calibration, the display appears as follows:

```
CALIBRATION
COMPLETE

Save & exit
Exit without saving
```

To save the calibration information, select "Save & exit". To exit without saving the data select "Exit without saving".

14. Any errors are reported by the following screens:

CALIBRATION  
Units must be gF  
Please try again  
Press ENTER

Displayed at the start of calibration if a disallowed unit is selected.

CALIBRATION  
Load not stable  
Please try again

Ensure that the load is not swinging, oscillating, or vibrating in any manner. Then try again.

CALIBRATION  
COMPRESSION  
Load too low  
Please try again

The calibration weight does not match the set value.

CALIBRATION  
TENSION  
Load too close  
to previous  
Please try again

The entered calibration point is too close to the previous point.

## 9 OTHER SETTINGS

### 9.1 Automatic Shutoff

The gauge may be configured to automatically power off following a period of inactivity while on battery power. Inactivity is defined as the absence of any key presses or load changes of 100 counts or less. To access these settings, select **Automatic Shutoff** from the menu. The display appears as follows:

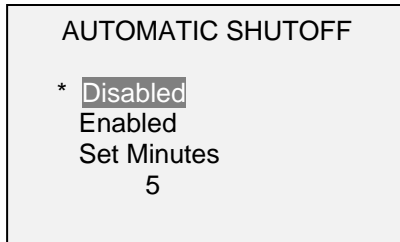

Selection	Description
<b>Disabled</b>	Disable automatic shutoff.
<b>Enabled</b>	Enable automatic shutoff.
<b>Set Minutes</b>	The length of time of inactivity. Available settings: 5-30, in 5 minute increments.

**Note:** If the AC adapter is plugged in, the gauge will ignore these settings and remain powered on until the **POWER** key is pressed.

### 9.2 Backlight

Several initial settings are available, upon powering on the gauge. To access these settings, select **Backlight** from the menu. The display appears as follows:



Select **Off** for the backlight to be off upon powering on the gauge.

Select **On** for the backlight to be on upon powering on the gauge.

Select **Auto** for the backlight to be on upon powering gauge, but will shut off after a period of inactivity (as defined in the **Automatic Shutoff** sub-section). The backlight will turn on again when activity resumes. The length of time of inactivity is programmed in minutes via the **Set Minutes** parameter. Available settings: 1-10, in 1 minute increments.

**Note:** If the AC adapter is plugged in, the gauge will ignore these settings and keep the backlight on. Selecting the **On** or **Off** setting in the **Backlight** menu will manually turn the backlight on or off as if the Backlight key were pressed.

### 9.3 LCD Contrast

The contrast of the display may be adjusted. Select **LCD Contrast** from the menu. The screen appears as follows:



Press **ENTER** to modify the contrast. Select a value from 0 to 25, 25 producing the most contrast.

#### 9.4 Initial Mode

This section is used to configure the initial mode upon powering on the gauge. To access this parameter, select **Initial Mode** from the menu. The screen appears as follows:

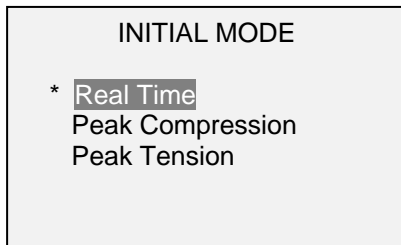

The default value is Real Time.

#### 9.5 Restore Default Settings

Default factory settings can be restored by selecting **Restore Defaults** from the menu. The settings may be found in the **Specifications** section. The screen appears as follows:

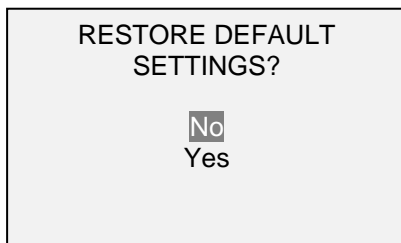

#### 9.6 Information / Welcome Screen

The following screen is displayed at power-up and can be accessed at any time by selecting **Information** from the menu:

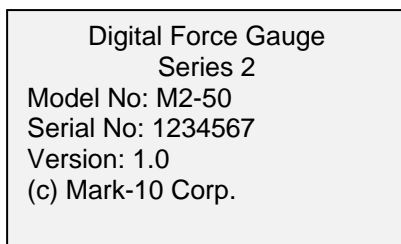

## 10 SPECIFICATIONS

### 10.1 General

<b>Accuracy:</b>	±0.5% of full scale
<b>Sampling rate:</b>	500 Hz
<b>Power:</b>	AC or rechargeable battery, with multi-step low battery indicator
<b>Battery life:</b>	<b>Backlight on:</b> up to 7 hours of continuous use <b>Backlight off:</b> up to 24 hours of continuous use
<b>Safe overload:</b>	200% of full scale (display shows "OVER" at 110% and above)
<b>Weight:</b>	<b>M2-2 – M2-100:</b> 0.7 lb [0.33 kg] <b>M2-200 – M2-500:</b> 0.9 lb [0.41 kg]
<b>Included items:</b>	Battery, quick-start guide, resource CD, certificate of conformance
<b>Load cell deflection:</b>	0.010 in [0.25 mm]
<b>Environmental requirements:</b>	40 - 100°F, max. 93% humidity, non-condensating
<b>Warranty:</b>	3 years (see individual statement for further details)

### 10.2 Factory Default Settings

Parameter	Setting
Filters	
Current	8
Displayed	128
Backlight	Auto
Minutes	1
Automatic Shutoff	Enabled
Minutes	5
LCD Contrast	10
Initial Mode	Real Time
Units	lbF

### 10.3 Capacity, Resolution & Load Cell Deflection

Model	lbF	kgF	N
M2-2	2 x 0.002	1 x 0.001	10 X 0.01
M2-5	5 x 0.005	2.5 x 0.002	25 x 0.02
M2-10	10 x 0.01	5 x 0.005	50 x 0.05
M2-20	20 x 0.02	10 x 0.01	100 x 0.1
M2-50	50 x 0.05	25 x 0.02	250 x 0.2
M2-100	100 x 0.1	50 x 0.05	500 x 0.5
M2-200	200 x 0.2	100 x 0.1	1000 x 1
M2-500	500 x 0.5	250 x 0.2	2500 x 2



10.4 Dimensions  
IN [MM]

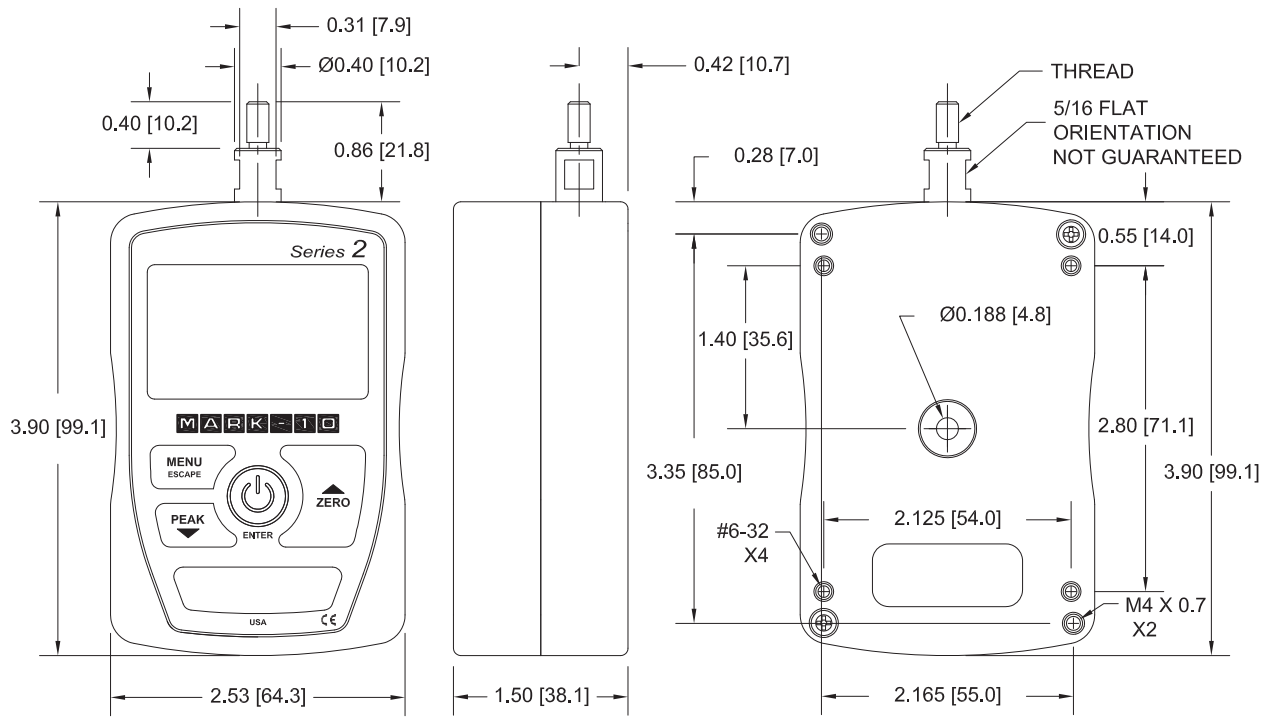

	Thread	Flat
M2-2 – M2-100	#10-32M UNF	5/16 [7.94]
M2-200 – M2-500	5/16-18M UNC	5/16 [7.94]



*Mark-10 Corporation has been an innovator in the force and torque measurement fields since 1979. We strive to achieve 100% customer satisfaction through excellence in product design, manufacturing and customer support. In addition to our standard line of products we can provide modifications and custom designs for OEM applications. Our engineering team is eager to satisfy any special requirements. Please contact us for further information or suggestions for improvement.*



*Force and torque measurement engineered better*

**Mark-10 Corporation**

11 Dixon Avenue  
Copiague, NY 11726 USA  
1-888-MARK-TEN  
Tel: 631-842-9200  
Fax: 631-842-9201  
Internet: [www.mark-10.com](http://www.mark-10.com)  
E-mail: [info@mark-10.com](mailto:info@mark-10.com)